

SeaTalk <-> NMEA SeaTalk <-> RS232 Converter

Installation and Operation

Manual

Hardware Version V 3.5

Software Version 1.45

April 2009

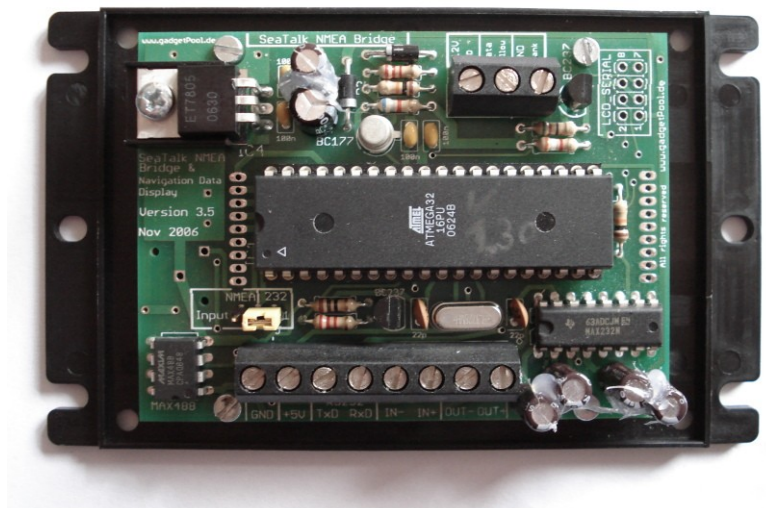

SeaTalk <-> NMEA SeaTalk <-> RS232 Converter

Contents

CREDITS / WARNING / DISCLAIMER.....	3
FUNCTION OVERVIEW.....	4
NMEA INPUT.....	4
NMEA OUTPUT.....	5
THE \$STALK SENTENCE.....	6
SEATALK INPUT.....	7
SEATALK OUTPUT.....	8
Collision detection	8
SAME TYPE OF DATA ON NMEA & SEATALK.....	8
SEATALK CONNECTION.....	9
NMEA / RS232 CONNECTION.....	10
INPUT JUMPER RS232.....	11
INPUT JUMPER RS422.....	13
RS422 IN -> RS232 OUT.....	15
CONFIGURATION SETTINGS.....	17
OPTIONS.....	20
LCD DISPLAY.....	20
PUSHBUTTON.....	21
SOFTWARE UPDATE	22
BOOTSTRAP LOADER METHOD.....	22
CIRCUIT DIAGRAM	23
SEATALK & NMEA CONVERSION TABLE.....	24
TERMINALS & CONNECTORS.....	25
ASCII TABLE.....	27

SeaTalk <-> NMEA SeaTalk <-> RS232 Converter

Credits / Warning / Disclaimer

The Protocol converter is a
RESEARCH PROJECT.

It is used for research on data communication, computer communication and data conversion on computers used on board boats.

Hard- and Software are still under development and have NOT been fully tested. Malfunctions of the protocol converter and of any connected device are possible at any time.

It is not an end user product and must not be used for navigation.

The protocol converter could cause damage to connected devices.

Liability **cannot** be accepted for any damages, personal injuries or malfunctions caused by the converter.

There are no Seataalk technical specifications available from the manufacturer. I have used the Technical Reference of the Seataalk protocol, compiled by Thomas Knauf GmbH. See <http://www.thomas-knauf.de/seataalk.htm> .Thank you to Thomas Knauf for his work.

Do not use for navigation

An operating GSM mobile phone should not be placed within 2m of an unshielded Seataalk/NMEA Bridge because of interference from the phone's radio transmissions. If a phone is brought closer than this 2m distance, the bridge may stop operating or data may become corrupted.
(Thank's John Blaiklock for testing)

SeaTalk <-> NMEA SeaTalk <-> RS232 Converter

Function overview

The converter interconnects two different data communication systems – SeaTalk¹ and NMEA.

- Information from the SeaTalk bus is transformed into NMEA Data and sent to the NMEA bus.
- Information from the NMEA bus is transformed into SeaTalk data and sent to the SeaTalk bus.
- Optionally information from both busses can be shown on a LCD display.

NMEA Input

Processing of NMEA data starts, when a complete NMEA sentence has been received.

If the received sentence contains a checksum, this checksum is used to check for communication errors. If the checksum does not match the sentence, the received NMEA sentence is discarded.

If the sentence does not contain a checksum, the sentence is always regarded as valid.

After complete reception and checksum verification the sentence is sent to the NMEA-Out port of the converter Board. (This function can be switched off by control setting – see below)

If the received sentence is known, the sentence information is extracted and processed. At this time the following NMEA sentences can be received:

\$xxRMC	Speed over Ground, Course over Ground, Latitude, Longitude, Time, Date
\$xxGLL	Position
\$xxVHW	Speed through water
\$xxRMB	Waypoint Information
\$xxAPB	Waypoint Information (only for Bridge without LCD Display)
\$xxBWC	Waypoint Information (only for Bridge without LCD Display)
\$xxDBT	Depth below transducer
\$xxDPT	Depth below keel
\$xxMTW	Water Temperature
\$xxVLW	Total / Trip Mileage
\$xxMWV	Wind angle Wind Speed
\$xxHDM	Heading magnetics
\$xxHDG	“ “
\$xxZDA	Date & Time
\$STALK	Special SeaTalk datagram
\$SNBSE	Board configuration

¹ SeaTalk is Reg. Trademark of Raymarine Inc.

SeaTalk <-> NMEA SeaTalk <-> RS232 Converter

NMEA Output

All valid NMEA sentences – whether processed by the converter or not – are forwarded to the NMEA-Out port.. If the NMEA-Out port is busy, the sentence is temporarily stored in memory and transmitted as soon as the NMEA-Out port becomes free.

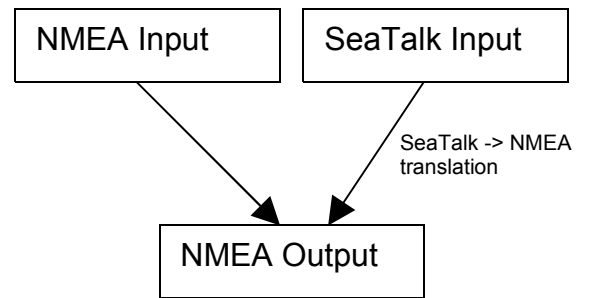

The converter also continuously checks for new incoming SeaTalk data. Incoming SeaTalk data is converted to NMEA Data and transferred to the NMEA-Out Port.

The following NMEA sentences can be sent :

\$IIDBT	Depth below transducer Optional \$IIDPT can be sent instead of \$IIDBT
\$IIVHW	Speed t. Water
\$IIMTW	Water Temperature
\$IIVLW	Total / Trip Mileage
\$IIMWV	Wind angle & Wind speed
\$IIHDM	Heading compass
\$IIRMC	Speed over ground, Course over ground, Latitude, Longitude, UTC time, Date Optional an additional \$IIGLL sentence can be sent for position information
\$IIRSA	Rudder angle
\$STALK	special SeaTalk datagram
\$SNBSE	special system configuration datagram

SeaTalk <-> NMEA SeaTalk <-> RS232 Converter

The \$STALK sentence

The converter can process a special NMEA-like sentence.
With this special sentence any SeaTalk command can be sent to SeaTalk.

\$STALK,cc,p1,p2...,pn*xx

cc = SeaTalk Command

p1 = Parameter1

p2 = Parameter 2

..

*xx = NMEA checksum (optional) .

This special sentence will be sent to the NMEA Bus for every received SeaTalk datagram
– regardless as to whether it was recognised and processed or not.
(This function can be switch off by control setting – see below)

SeaTalk <-> NMEA SeaTalk <-> RS232 Converter

SeaTalk Input

When a SeaTalk datagram was received the system checks if this datagram is known and should be processed. When the datagram is known, all datagram parameters are extracted and stored.

Any unknown datagram is ignored.

(Exception: \$STALK is sent even for unknown datagrams)

At this time the following SeaTalk datagrams can be received.

- 00 Depth
- 10 Wind angle
- 11 Wind speed
- 20 Speed through water
- 21 Trip mileage
- 22 Total mileage
- 23 Water temperature
- 25 Total & trip mileage
- 26 Speed through water
- 27 Water temperature
- 30 Lamp intensity
- 50 Latitude
- 51 Longitude
- 52 Speed over ground
- 53 Course over ground
- 54 UTC time
- 56 Date
- 58 Latitude & Longitude
- 84 Compass heading
- 89 Compass ST40 heading
- 9C Compass heading & rudder position

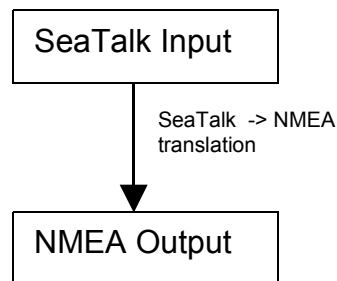

SeaTalk <-> NMEA SeaTalk <-> RS232 Converter

SeaTalk Output

The converter periodically checks if any new data has arrived from NMEA, that needs to be sent to SeaTalk. New data is written to the SeaTalk bus only if the bus is not in use by any other instrument. If the bus is in use, the converter waits for a while, and tries again.

Collision detection

Every single bit sent out to the SeaTalk bus is read back again and checked for successful transmission. If the transmission was corrupted, the transmission is stopped immediately. When the bus becomes free, the transmission will be started again.

At this time the following SeaTalk datagrams can be sent

00	Depth
10	Wind angle
11	Wind speed
20	Speed through water
25	Total & Trip mileage
27	Water temperature
30	Lamp intensity
50	Latitude
51	Longitude
52	Speed over ground
53	Course over ground
54	Time
56	Date
82	Target Waypoint Name
85	Navigation to Waypoint information
89	Compass ST40 heading

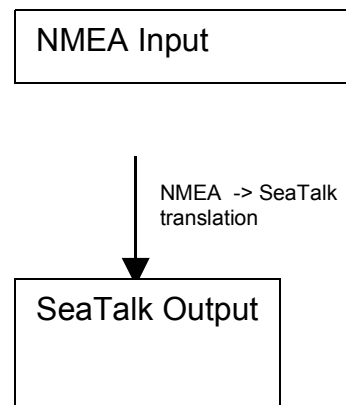

Same type of Data on NMEA & SeaTalk

Information available from like instruments on both Busses (SeaTalk & NMEA) are not converted.

Example:

We have a depth sounder on the SeaTalk Bus and another depth sounder on the NMEA bus.

So, on both sides depth information is available.

In this case no depth information is transferred from one bus to the other.

(If depth information is not updated within 30 sec. on one bus, sending to the other bus is activated again.)

SeaTalk <-> NMEA SeaTalk <-> RS232 Converter

SeaTalk Connection

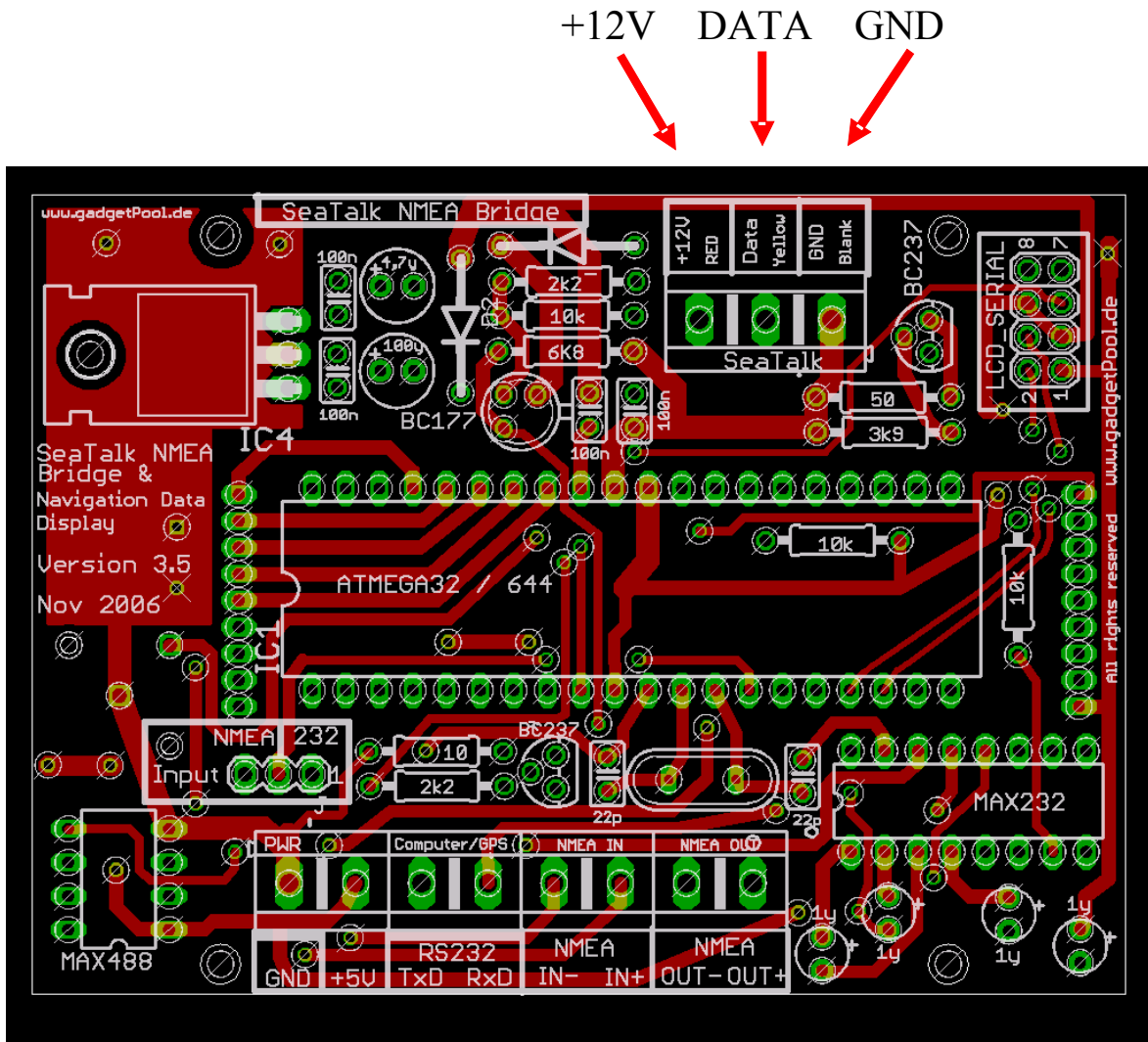

There is a 3-Pin terminal for the connection to the SeaTalk bus.
Please double check for correct connection.
The board takes it's power supply from +12V and GND.
+12V & GND MUST be connected, even if the SeaTalk bus is not needed.

A wrong connection could damage the converter or other devices on the SeaTalk Bus.

SeaTalk <-> NMEA SeaTalk <-> RS232 Converter

NMEA / RS232 Connection

Choosing RS232 <-> RS422

The **Serial IN** ports can be used as RS232 or RS422 port by setting a jumper.

RS232 setting is used for connecting a PC, a notebook, a GPS mouse, a Garmin GPS, or any other device with a RS232 port.

RS422 is used for standard NMEA devices.

Standard NMEA devices have terminals marked with NMEA IN+, NMEA IN- , while RS232 devices usually have RxD, TxD .

Please double check the correct Jumper setting before usage.

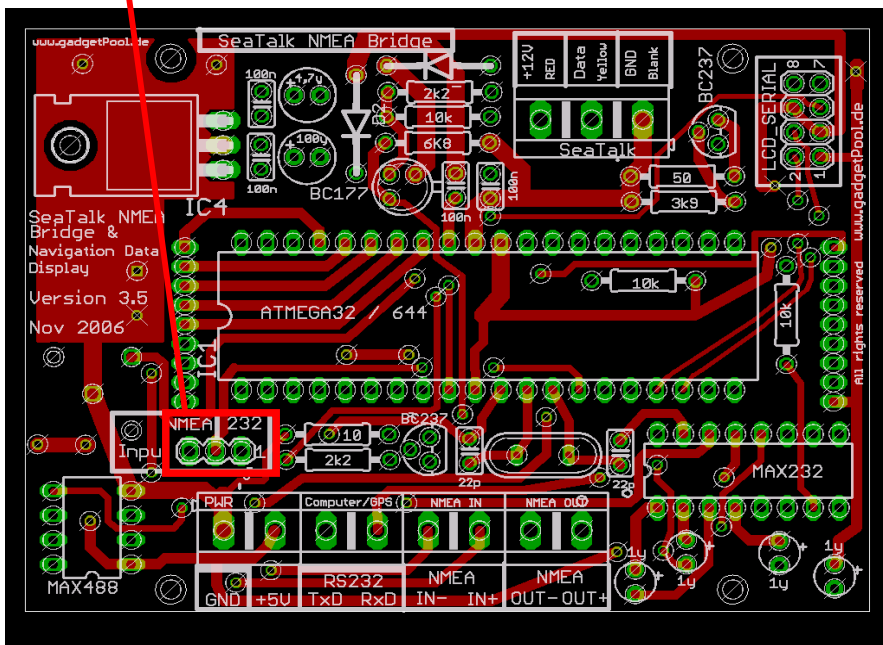
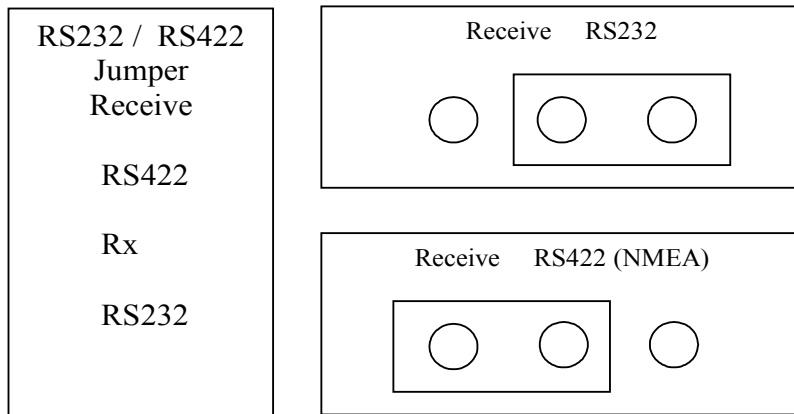

You must use **only 1** input port.

© 2004 All Rights Reserved
© 2004 Alle Rechte vorbehalten

HW Version 3.5 / SW Version 1.45
Page 10 of 26

<http://www.gadgetPool.de>
FWallenwein@gadgetPool.de

SeaTalk <-> NMEA SeaTalk <-> RS232 Converter

Either RxD + GND with Jumper setting RS232
Or IN+/IN- with Jumper setting RS422
It is not possible to use both Input ports at the same time.

Both Output port are always enabled. The SeaTalk NMEA Bridge always sends data to the RS232 Port and to the RS422 Port
You can - for example - send data from the SeaTalk NMEA Bridge to a Computer **and** a GMDSS Radio.

Input Jumper RS232

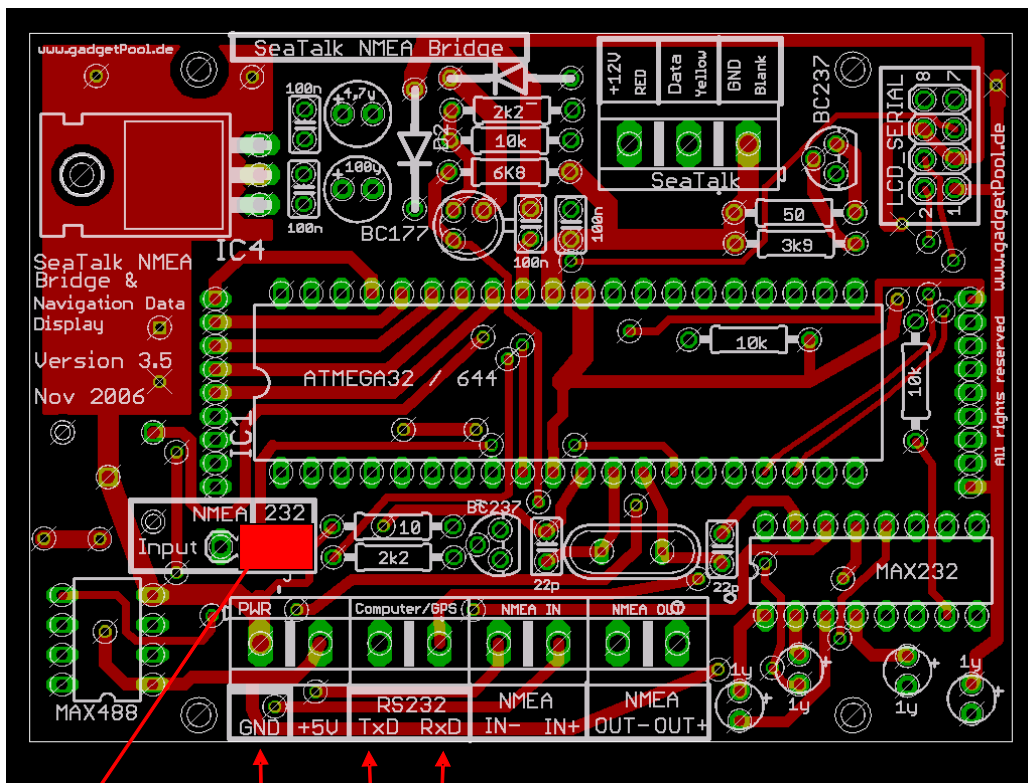

GND TxD RxD

 = Jumper

In this setting the terminals marked RxD and GND and are used for NMEA input.

The bridge sends NMEA Data to the Ports TxD/GND and NMEA OUT+/NMEA OUT-

SeaTalk <-> NMEA SeaTalk <-> RS232 Converter

Example : Sending & Receiving SeaTalk Data to/from a Computer

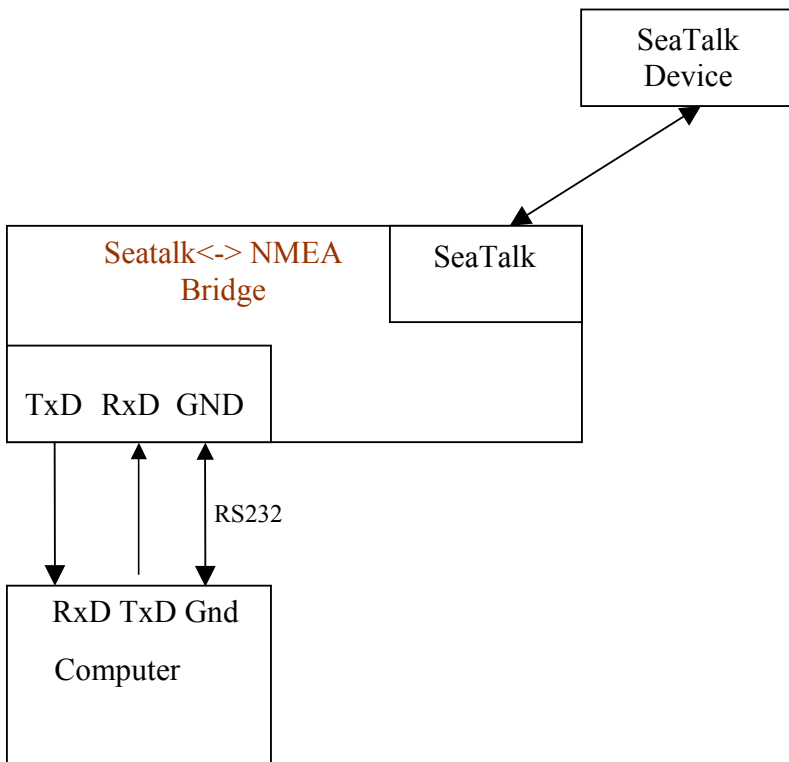

In this configuration SeaTalk Data can be received from the Computer AND the computer can send Data to the SeaTalk bus.

Example : Connecting a Garmin GPS, and Computer and the SeaTalk Bus.

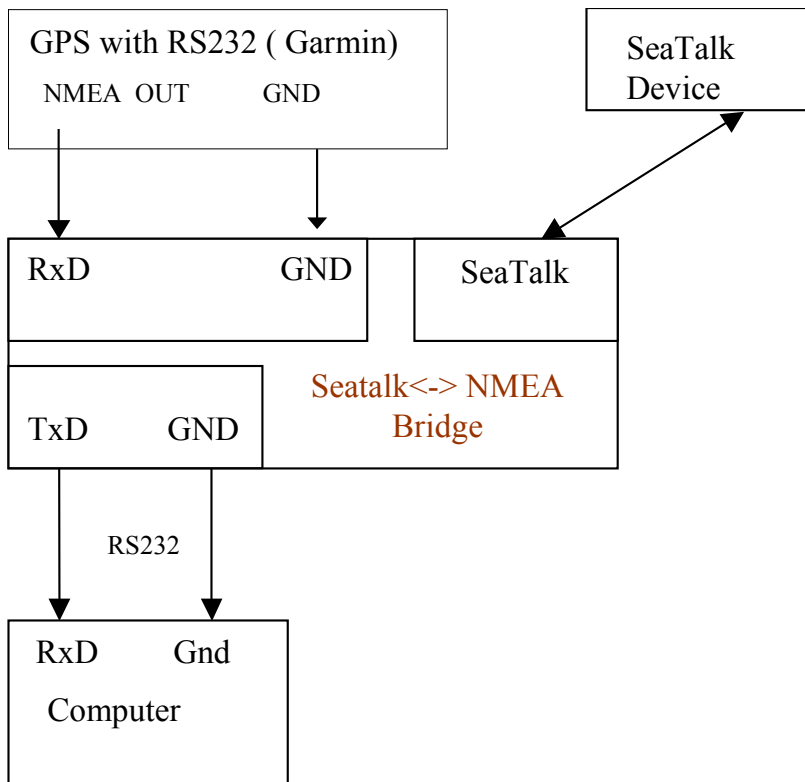

In this configuration the GPS sends Data to the Computer AND to the SeaTalk bus. The Computer can only receive Data from the GPS and from the SeaTalk bus. It can not send any data.

SeaTalk <-> NMEA SeaTalk <-> RS232 Converter

Input Jumper RS422

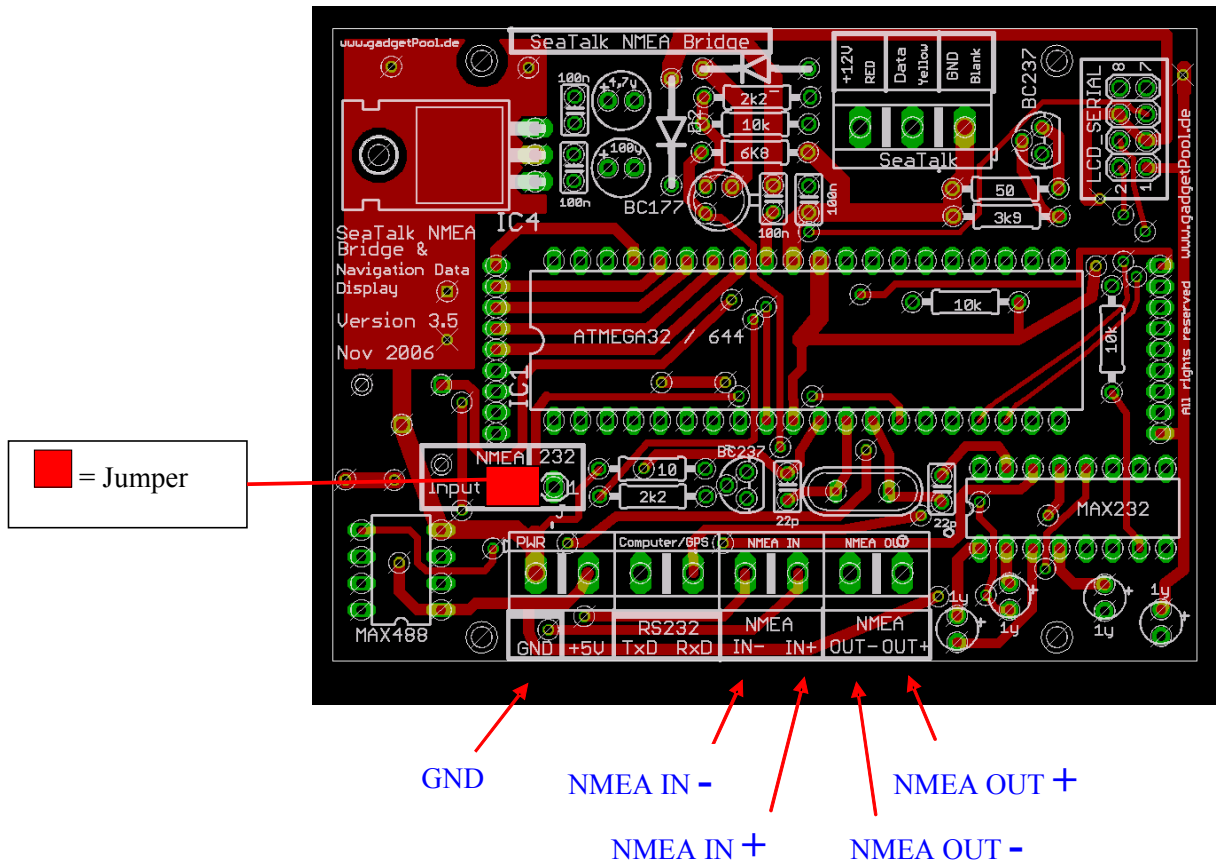

In this configuration the terminals NMEA-IN+ and NMEA-IN- are used to receive NMEA Data.

The bridge sends NMEA Data out to the Ports TxD/GND and NMEA OUT+/NMEA OUT-

The terminal "RS232-RxD" is not used.

On some devices the NMEA terminals are labelled with **A** and **B** instead of **+** and **-**
On some devices the NMEA terminals + and - are even reversed. If communication can not be established, just try to swap NMEA + and NMEA - . Swapping NMEA + and NMEA - only results in communication failure.

!! Please check your manual before connecting !!

SeaTalk <-> NMEA SeaTalk <-> RS232 Converter

RS422 In -> RS232 Out

You can use the SeaTalk NMEA Bridge to connect a RS422 device to an RS232 computer.

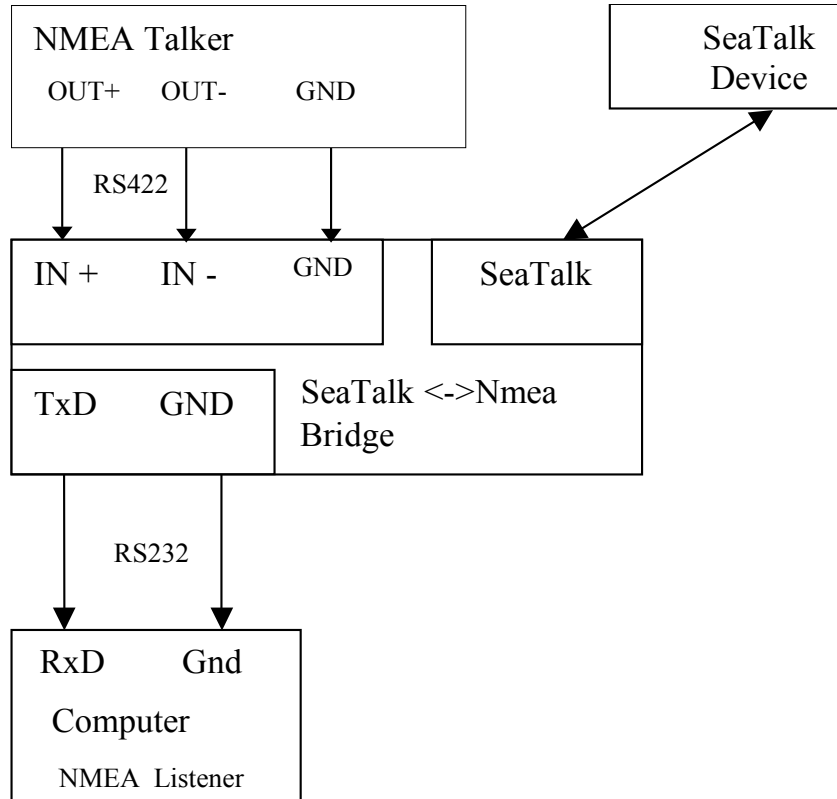

Use Jumper settings for RS422.

Data input comes from RS422 IN+/IN-, Data output is sent to RS232-TxD and RS422 Out+/Out-. Of course SeaTalk Data can also be read and sent.

SeaTalk <-> NMEA SeaTalk <-> RS232 Converter

RS232 In -> RS232 & RS422 Out

Since Output is always routed to both out-ports, you can connect two different devices to the output ports.

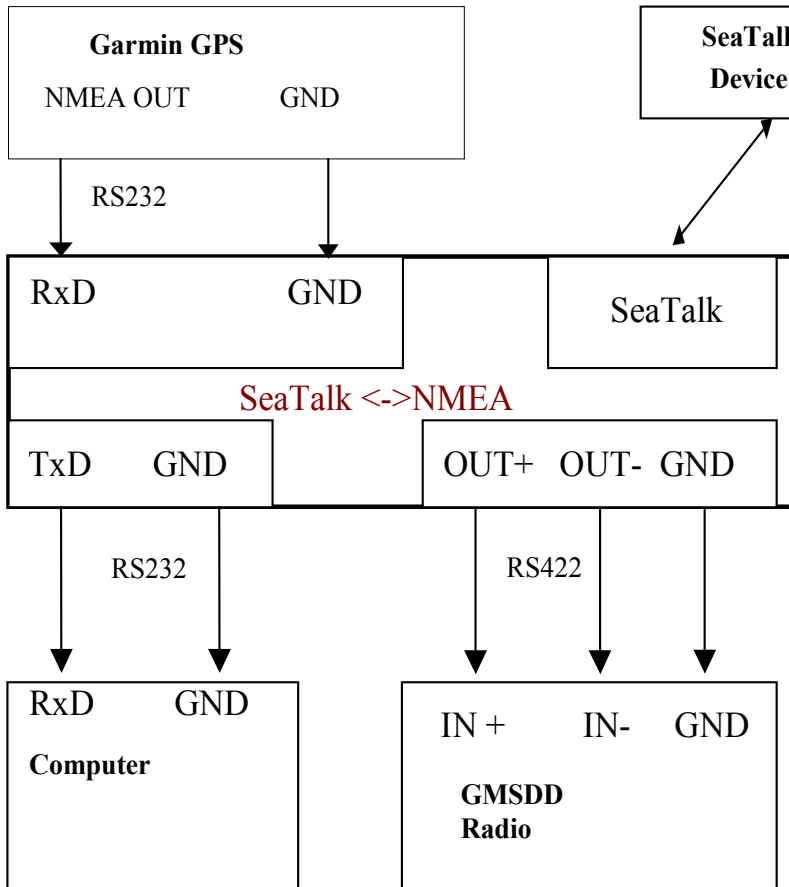

In this example the GPS sends Data to the SeaTalk Bus and to the computer and to a GMDSS radio.

Computer and GMSDD Radio receive data from GPS and from SeaTalk instruments.

SeaTalk Instruments receive data from other SeaTalk instruments and from GPS.

The computer cannot send any data.

SeaTalk <-> NMEA SeaTalk <-> RS232 Converter

Configuration settings

The SeaTalk NMEA converter can be configured to meet the users requirements.

The configuration is made by sending a NMEA-like sentence. The settings are stored in an EEPROM.

The configuration sentence is :

\$SNBSE,address,data<CR><LF>

(Optionally a Checksum can be appended \$SNBSE,address,data*XX<CR><LF>)

(SNBSE = **S**eatalk **N**MEA **B**ridge **S**et **E**eprom)

Configuration settings are read, when the bridge gets switched on. So when you change the configuration, you need to switch it off/on to activate the changes.

How to set the configuration :

Connect the bridge to a PC.

Open a terminal program (i.e. hyperterm) and set it to 4800 Baud, 8 Bit, no parity, no handshake.

Type " \$xxx " and press ENTER



Bridge responds with " \$xxx ". When you receive the \$xxx, connection to your bridge is ok. If \$xxx does not appear after you pressed ENTER, check connection, setting of Com-Port, Baudrate etc.

Example :

In this example, we configure the bridge, so that every incoming SeaTalk sentence will be sent to the PC as \$STALK,xx,yy sentence.

In your terminal program enter

\$SNBSE,0,1



The bridge will respond with

\$SNBSE,0,1

Next time you switch the bridge on, it will send every incoming SeaTalk sentence to the PC as a \$STALK,xx,yy,zz ... sentence.

SeaTalk <-> NMEA SeaTalk <-> RS232 Converter

Address	Data
0	1 = Send out every incoming SeaTalk datagram as "\$STALK....." to NMEA 0 = Do not generate \$STALK,xx,yy sentence for each incoming SeaTalk datagram If you don't really need this function – better switch if OFF. It causes additional load on the NMEA Bus.
1	Set NMEA Port Baudrate 1 = 300 Baud 2= 600 Baud 3= 1200 Baud 4 = 2400 Baud 5 = 4800 Baud (Default) 6 = 9600 Baud 7 = 19200 Baud 8 = 38400 Baud any other value defaults to 4800 Baud Baud rate is changed at next start of the converter Warning : The baudrate selected is also the baudrate used for any further configuration. If your configuration program can not handle the selected baudrate, there is no way to reconfigure the device.
2+3	Prefix for generated NMEA Sentence - Character 1+2 Every NMEA Sentence generated from the system begins with this two letters Default = "II" (Integrated Instrumentation) WARNING You have to enter the ASCII Value of the character, not the character itself. Example : To set character 1 to "I" and character 2 to "A" \$SNBSE,2,73 (Character "I" is a 73 in ascii) \$SNBSE,3,65 (Character "A" is a 65 in ascii) See Ascii Table
4	1= Echo every incoming NMEA Sentence 0 = Do not echo incoming NMEA sentences
5	N.A.
6	1 = Send \$IIVHW Sentence when new Data from SeaTalk arrives 0 = Do not send \$IIVHW Sentence
7	1 = Send \$IIHDM Sentence when new Data from SeaTalk arrives 0 = Do not send \$IIHDM Sentence
8	1 = Send \$IIMWV Sentence when new Data from SeaTalk arrives 0 = Do not send \$IIMWV Sentence
9	1 = Send \$IIDBT Sentence when new Data from SeaTalk arrives 0 = Do not send \$IIDBT Sentence
10	1 = Send \$IIMTW Sentence when new Data from SeaTalk arrives 0 = Do not send \$IIMTW Sentence
11	1 = Send \$IIVLW Sentence when new Data from SeaTalk arrives 0 = Do not send \$IIVLW Sentence
12	Not used for USB SeaTalk bridge
13	1 = Send welcome message after power up

**SeaTalk <-> NMEA
SeaTalk <-> RS232
Converter**

	0 = Do not send welcome message
14	0 = Speed over Ground from NMEA input is sent to SeaTalk bus as Speed over Ground and as Speed through Water (Needed for ST60 Wind instrument, that does not recognise Speed Over Ground) 1 = Normal operation. No special SOG => STW handling) (default) (See Webpage www.gadgetPool.de for more on this special ST60 Wind function)
15	0 = Every incoming SeaTalk datagram is sent to NMEA as "\$STALK,xxx,yyy – no matter if the system can interpret the SeaTalk data or not. 1 = Normal operation. Only SeaTalk sentences known to the system are echoed as \$STALK,xxx,yyy Only valid if Address "0" is switch on.
16	0 = Don't send any data to the SeaTalk Port. SeaTalk Port is READ-ONLY
17	0 = Display windspeed in knots. 1= Display windspeed in m/s
18	0 = Don't send SOG to SeaTalk 1 = Send SOG to SeaTalk
19	0 = Don't send Position to SeaTalk 1= Send Position to SeaTalk
20	0 = Display depth on SeaTalk instrument in feed, 1 = display in Meters
21	Currently not used
22	0=send only RMC sentence for position 1=send GLL and RMC sentence for position
23	23+24 Offset of depth transducer. In mm (+- 1000th Meter) If this value is set to -1, the bridge will send DBT NMEA Sentence and no offset will be used. If this values is set to something between -32000 to 32000, the bridge will produce DPT sentences including the offset.
25	Reserved. (Used for SeaTalk NMEA Link)
26	1 = send Nmea RSA sentence for rudder angle data 0 = dont send RSA sentence
27	Reserved. Not used for SeaTalk Nmea Bridge
28	0= Course over Ground from NMEA input is also sent to SeaTalk bus as compass course 1 = Normal operation. No special COG => CMAG handling) (default)

SeaTalk <-> NMEA SeaTalk <-> RS232 Converter

Options

The NMEA SeaTalk converter is normally used without any visualisation or user input. Optionally however, a LCD Display and a Pushbutton can be connected.

In standard mode – without LCD and Pushbutton – the board consumes less power and data conversion is faster than with LCD.

LCD Display

If data visualisation is needed, a serial 4x20 character LCD Display Type „LCD Modul EA-DIP204-4“ can be connected.

It is available from

- Conrad Elektronik - www.conrad.de Part No. 181863-14
- [Electronic Assembly GmbH](http://www.lcd-module.de/) <http://www.lcd-module.de/>

Display illumination can be switched on/off by a pushbutton or by SeaTalk command.

The display shows :

Page 1 :	Speed through water, Depth, Position Long. Position Lat.	Speed over ground Temperature Track
Page 2 :	App. Wind Speed. Compass Trip Miles Total Miles	App. Wind Direction Track UTC-Time
Page 3 :	Route FROM Waypoint Name Heading to WP Distance to WP	Route TO Waypoint Name Current Bearing X-Track Error

The displayed values are blanked out if no new data has been received for more than 30 seconds.

SeaTalk <-> NMEA SeaTalk <-> RS232 Converter

Pushbutton

When an LCD Display is connected, the user can switch between two display pages. Pressing the pushbutton for a short time (approx. 2 sec) switches between the pages. Pressing the pushbutton for a longer time (approx. 5 sec) switches the display illumination on/off.

Switching illumination on/off can be transmitted to SeaTalk bus. With this function the lights on all other instruments on the Seataalk bus can be remote controlled.

SeaTalk <-> NMEA SeaTalk <-> RS232 Converter

Software update

The Software can be updated by using the built in Bootstrap-Loader function.

If you find anything missing in the Software, if you should find any software errors or if you have new Ideas – just sent a mail to FWallenwein@tklinux.de

I can send new / revised software by E-Mail and you can update the controller software yourself.

Bootstrap method advantages :

No Hardware programmer needed.

Just a RS232 connection to PC and a PC Software is needed.

Fuses and Bootstrap Software can not be erased accidentally.

Latest Software versions can be found at <http://www.gadgetPool.de>

Bootstrap Loader Method

Set Jumpers to RS232.

Connect the SeaTalk NMEA Bridge to your PC (using RxD, TxD and GND)

Start the supplied bootstrap software on the PC.

Open the Image file you would like to program into the Bridge.

Select your serial port in bootstrap software

Select **9600 Baud**

Switch on the SeaTalk NMEA Bridge.

The Bootstrap Software finds the SeaTalk NMEA Bridge and flashes the new software.

**SeaTalk <-> NMEA
SeaTalk <-> RS232
Converter**

SeaTalk & NMEA conversion Table

Function	SeaTalk ID	NMEA	Stalk -> NMEA	NMEA->Stalk
Depth	00	DBT	X	X
Speed t. water	20	VHW	X	X (See SNBSE,14)
Speed t. water	26	VHW	X	
Trip mileage	21	VLW	X	
Total mileage	22	VLW	X	
Water temperature	23	MTW	X	
Water temperature	27	MTW	X	X
Total / Trip mileage	25	VLW	X	X
Wind angle	10	MWV	X	X
Wind speed	11	MWV	X	X
Compass	84	HDM (VHW)	X	
Compass ST40	89	HDM	X	X
Speed over ground	52	RMC	X	X
Course over ground	53	RMC	X	X
Lamp intensity	30		X	Pushbutton
Latitude	51	RMC	X	X
Latitude	51	GLL		X
Longitude	50	RMC	X	X
Longitude	50	GLL		X
UTC time	54	RMC	X	X
UTC time	54	ZDA		X
Date	56	RMC	X	X
Date	56	ZDA		X
Waypoint Name	82	RMB		X
Waypoint Data	85	RMB		X
Special NM->ST	any	\$STALK	X	X
Special config.	-	\$\$SNBSE		

SeaTalk <-> NMEA SeaTalk <-> RS232 Converter

Terminals & Connectors

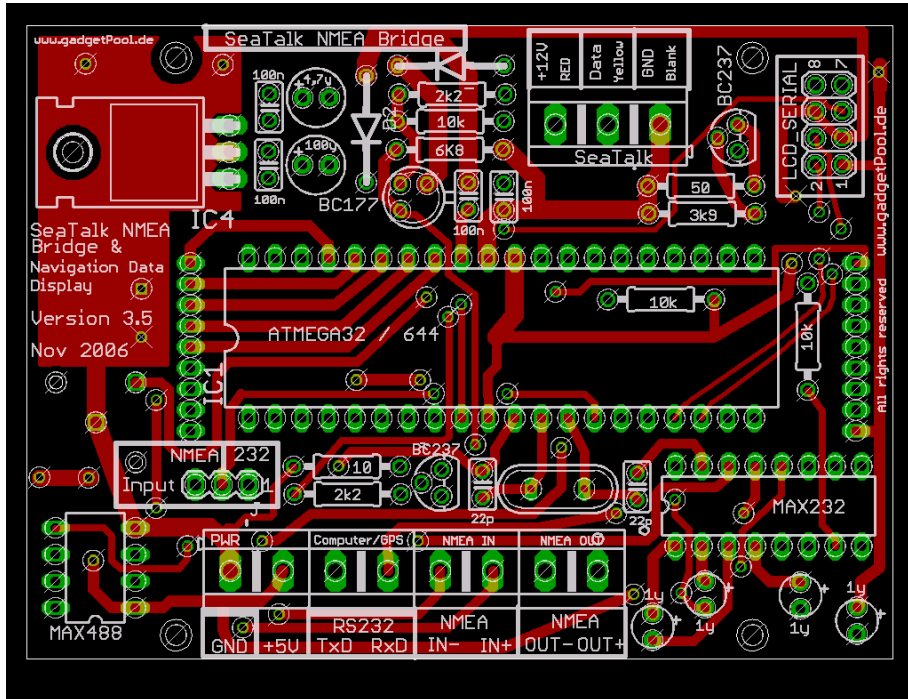

Terminal on the left side

+5V	5Volt Output (for GPS Mouse etc.)
GND	Ground (For RS232, GPS Mouse etc.)
TxD	RS232 Transmit Data. Serial Data sent from bridge to a PC
RxD	RS232 Receive Data. Serial Data received by the bridge from PC
IN+/IN-	NMEA Data Input (RS422)
OUT+/OUT-	NMEA Data Output (RS422)

Terminal on the right side

+12V	12 Volt Power Supply	Plus
Data	SeaTalk In/Output	
GND	12 Volt Power Supply	Minus (GND)

If you use the 5V output to power other devices please make sure, that the chip 7805 has a heat sink. This chip can get very hot if it has no heat sink attached.

**SeaTalk <-> NMEA
SeaTalk <-> RS232
Converter**

News and Info on the web.

If you have any question or suggestions – there is a SeaTalk NMEA Bridge forum on our web page. <http://www.gadgetPool.de>

**SeaTalk <-> NMEA
SeaTalk <-> RS232
Converter**

ASCII Table

Upper case letters

Character	Ascii Value
A	65
B	66
C	67
D	68
E	69
F	70
G	71
H	72
I	73
J	74
K	75
L	76
M	77
N	78
O	79
P	80
Q	81
R	82
S	83
T	84
U	85
V	86
W	87
X	88
Y	89
Z	90

Lower case letters

a	97
b	98
c	99
.....	
x	120
y	121
z	122

Digits

0	48	6	54
1	49	7	55
2	50	8	56
3	51	9	57
4	52		
5	53		